

产品名称 Product name

- ▶ 2.54PH H2.5 1*nPin SMT
- ▶ PC5.0 PA6.0 PB3.2 L11.0(右前左后)

产品应用场景 Product application scenario

- ▶ 电子通讯/数码产品/家用电器
- ▶ 外围设备/汽车/医疗设备等.
- ▶ Electronic communication/digital products/household appliance peripherals/AuTomobile/medical equipment, etc

排针系列™
Needle arrangement series™

产品参数/Product parameters

额定电流 (Rated current): 1.5A AC/DC

盐雾实验 (Life Test): 24 hours

接触电阻 (Contact Resistance): 20mΩ

绝缘电阻 (Insulation Resistance): 1000MΩ min.

耐电压 (Withstand voltage): AC 500V

工作温度 (Operating Temperature): -40° C to 105°

防火等级 (Fire rating): Polyester (UL94V-0)

触点电镀 (Dielectric Strength): Gold Flash

耐高温范围/时长 (High temperature resistance range/duration): 260° C for 5seconds

包装方式 (Packaging method): 袋装

材质/MATERIALS:

No.	名称/NAME	材料/MATERIAL	表面处理/颜色 Surfacetreatment/color
①	端子/Terminal	Brass/C2680	镀金 gold-plating
②	塑胶/plastic cement	PBT/PA6T	黑色 Black

产品PIN位示意图/Schematic diagram of product PIN

No. of	DIM. A	DIM. B	No. of	DIM. A	DIM. B	No. of	DIM. A	DIM. B	No. of	DIM. A	DIM. B
1*1P	0.00	2.54	1*11P	25.40	27.94	1*21P	50.80	53.34	1*31P	76.20	78.74
1*2P	2.54	5.08	1*12P	27.94	30.48	1*22P	53.34	55.88	1*32P	78.74	81.28
1*3P	5.08	7.62	1*13P	30.48	33.02	1*23P	55.88	58.42	1*33P	81.28	83.82
1*4P	7.62	10.16	1*14P	33.02	35.56	1*24P	58.42	60.96	1*34P	83.82	86.36
1*5P	10.16	12.70	1*15P	35.56	38.10	1*25P	60.96	63.50	1*35P	86.36	88.90
1*6P	12.70	15.24	1*16P	38.10	40.64	1*26P	63.50	66.04	1*36P	88.90	91.44
1*7P	15.24	17.78	1*17P	40.64	43.18	1*27P	66.04	68.58	1*37P	91.44	93.98
1*8P	17.78	20.32	1*18P	43.18	45.72	1*28P	68.58	71.12	1*38P	93.98	96.52
1*9P	20.32	22.86	1*19P	45.72	48.26	1*29P	71.12	73.66	1*39P	96.52	99.06
1*10P	22.86	25.40	1*20P	48.26	50.80	1*30P	73.66	76.20	1*40P	99.06	101.60

产品编号/Product No



- 1: Series No: PH-Pin Header
- 2: 焊接板类型/Welding Board Type:
4-右前左后/ SMT Type with Locating Peg
- 3: 产品间距/Product spacing
127-1.27mm
200-2.00mm
254-2.54mm
- 4: PIN位/PIN bit
1*1P-11P

- 5: 颜色/Color:
B-Black
- 6: 材料/Material
1-PBT 2-PA6T
- 7: 触点电镀/Contact Plating
GO-Gold Flash
- 8: 包装方式/Packgin Method
P-袋装/PE B-盒装/BOX
T-管装/Tubing W-卷带/winding
- 9: Serial Code

连接器领域专家
让世界连接更清晰

产品订购号示意图/Schematic diagram of product order number

Schematic diagram of product order number: HB-PH4-25411PB2G0P

产品外形尺寸图/Outline dimension drawing of product

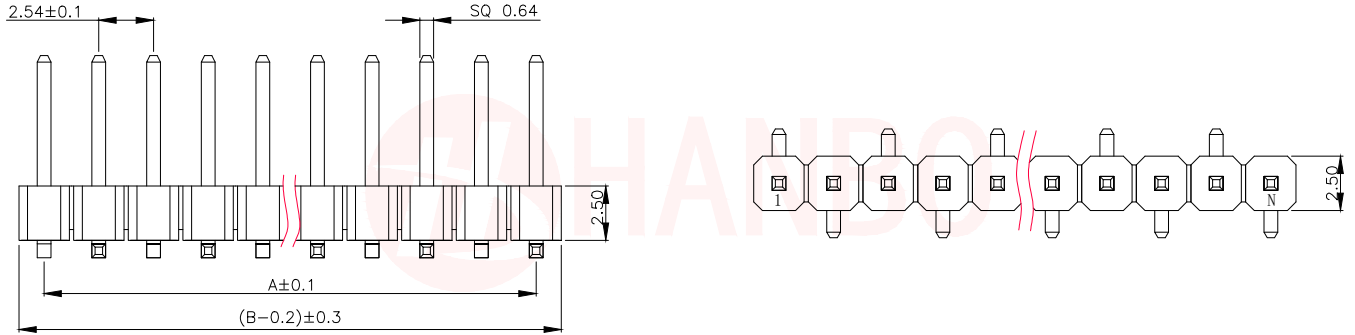

线路图/Circuit diagram

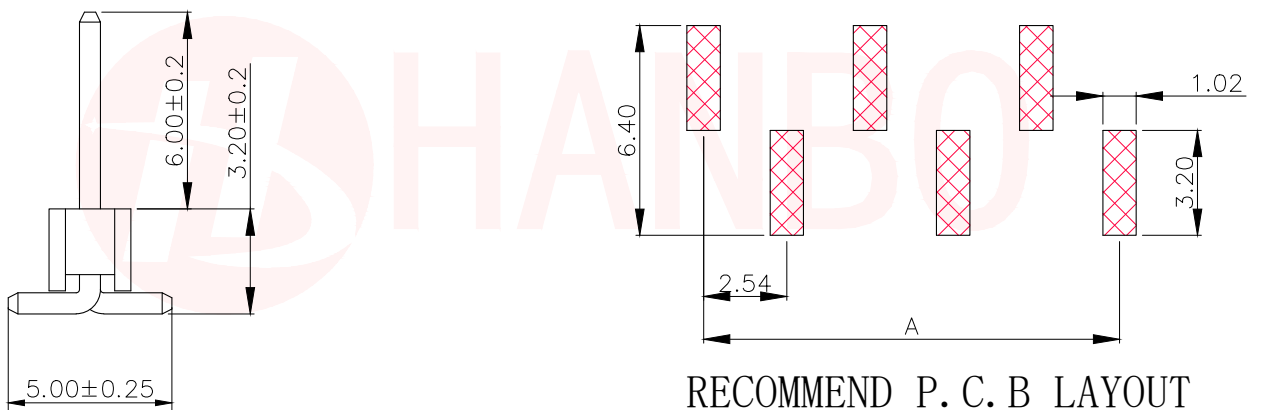

RECOMMEND P. C. B LAYOUT
PCB TOLERANCE: ± 0.05 (TOP VIEW)

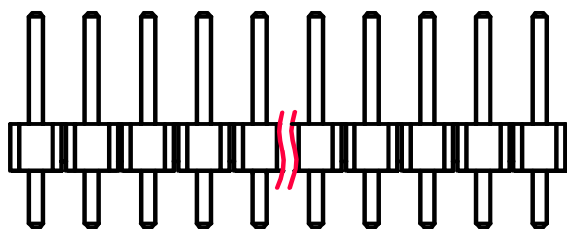

产品

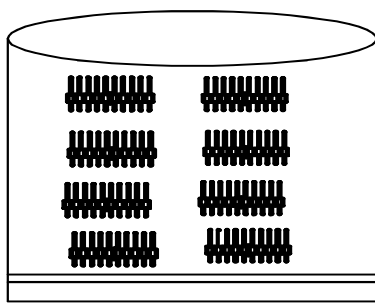
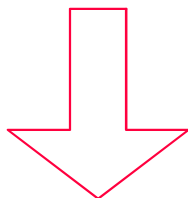

3#胶袋: 16*18cm

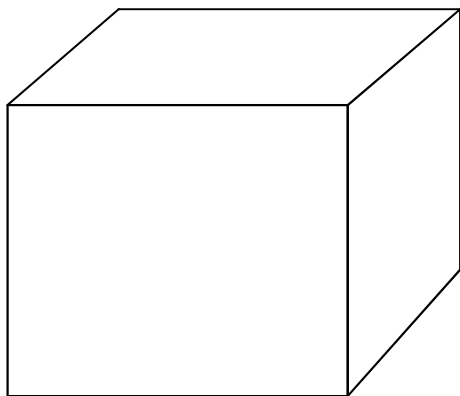
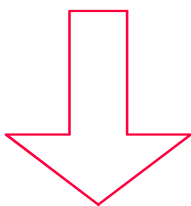

纸箱

series
HANBO
TM
插针系列

连接器领域专家
让世界连接更清晰