

产品参数/Product parameters

额定电流 (Rated current): 1.5A AC/DC

盐雾实验 (Life Test): 24 hours

接触电阻 (Contact Resistance): 20mΩ

绝缘电阻 (Insulation Resistance): 1000MΩ min.

耐电压 (Withstand voltage): AC 500V

工作温度 (Operating Temperature): -40° C to 105°

防火等级 (Fire rating): Polyester (UL94V-0)

触点电镀 (Dielectric Strength): Gold Flash

耐高温范围/时长 (High temperature resistance range/duration): 260° C for 5seconds

包装方式 (Packaging method): 袋装

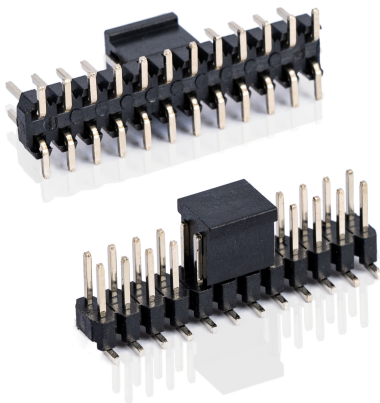

产品名称
Product name

- ▶ 2.0PH H2.0 2*nPin 双排
- ▶ 贴片SMT PC6.5 PA3.8
- ▶ PB2.5 L8.0

产品应用场景
Product application scenario

- ▶ 电子通讯/数码产品/家用电器
- ▶ 外围设备/汽车/医疗设备等.
- ▶ Electronic communication/digital products/household appliance peripherals/AuTomobile/medical equipment, etc

材质/MATERIALS:

No.	名称/NAME	材料/MATERIAL	表面处理/颜色 Surfacetreatment/color
①	端子/Terminal	Brass/C2680	镀金 gold-plating
②	塑胶/plastic cement	PBT/PA6T	黑色 Black

产品PIN位示意图/Schematic diagram of product PIN

No. of	DIM. A	DIM. B	No. of	DIM. A	DIM. B	No. of	DIM. A	DIM. B	No. of	DIM. A	DIM. B
2*1P	0.00	2.00	2*11P	20.00	22.00	2*21P	40.00	42.00	2*31P	60.00	62.00
2*2P	2.00	4.00	2*12P	22.00	24.00	2*22P	42.00	44.00	2*32P	62.00	64.00
2*3P	4.00	6.00	2*13P	24.00	26.00	2*23P	44.00	46.00	2*33P	64.00	66.00
2*4P	6.00	8.00	2*14P	26.00	28.00	2*24P	46.00	48.00	2*34P	66.00	68.00
2*5P	8.00	10.00	2*15P	28.00	30.00	2*25P	48.00	50.00	2*35P	68.00	70.00
2*6P	10.00	12.00	2*16P	30.00	32.00	2*26P	50.00	52.00	2*36P	70.00	72.00
2*7P	12.00	14.00	2*17P	32.00	34.00	2*27P	52.00	54.00	2*37P	72.00	74.00
2*8P	14.00	16.00	2*18P	34.00	36.00	2*28P	54.00	56.00	2*38P	74.00	76.00
2*9P	16.00	18.00	2*19P	36.00	38.00	2*29P	56.00	58.00	2*39P	76.00	78.00
2*10P	18.00	20.00	2*20P	38.00	40.00	2*30P	58.00	60.00	2*40P	78.00	80.00

产品编号/Product No



- 1: Series No: PH-Pin Header
- 2: 焊接板类型/Welding Board Type: 9-双排SMT/SMT Type with Locating Peg
- 3: 产品间距/Product spacing: 127-1.27mm, 200-2.00mm, 254-2.54mm
- 4: PIN位/PIN bit: 2*1P-21P

- 5: 颜色/Color: B-Black
- 6: 材料/Material: 1-PBT 2-PA6T
- 7: 触点电镀/Contact Plating: GO-Gold Flash
- 8: 包装方式/Packgin Method: P-袋装/PE B-盒装/BOX T-管装/Tubing W-卷带/winding
- 9: Serial Code

排针系列

连接器领域专家

让世界连接更清晰

产品订购号示意图/Schematic diagram of product order number

Schematic diagram of product order number: HB-PH9-20021PB2G0P

产品外形尺寸图/Outline dimension drawing of product

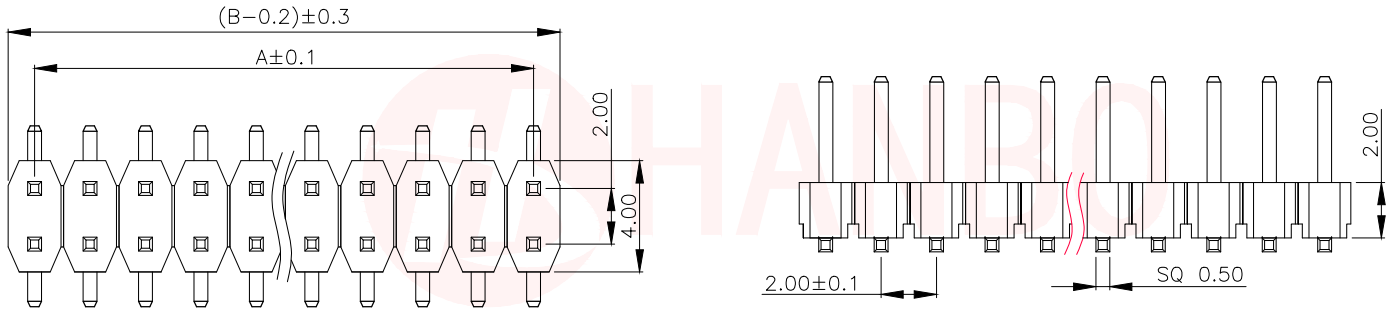

线路图/Circuit diagram

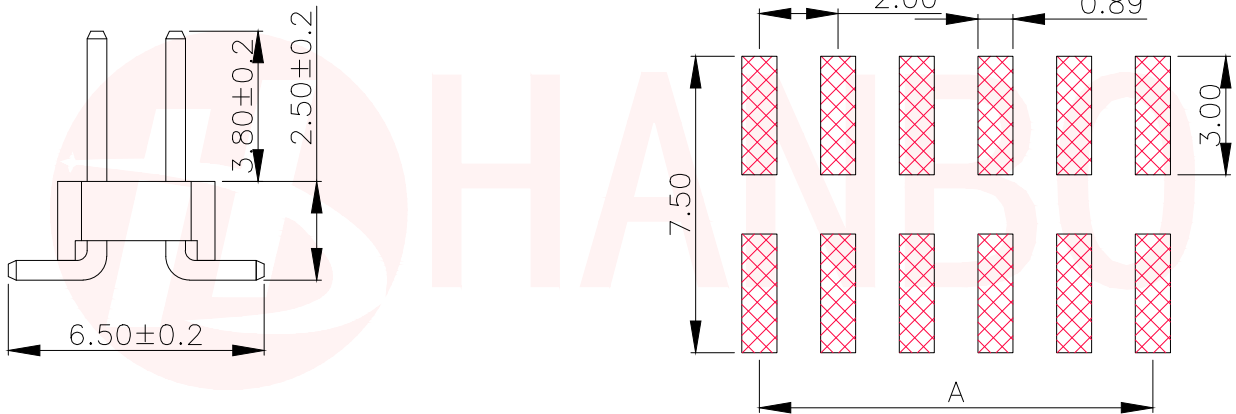

RECOMMEND P. C. B LAYOUT

PCB TOLERANCE: ± 0.05 (TOP VIEW)



产品

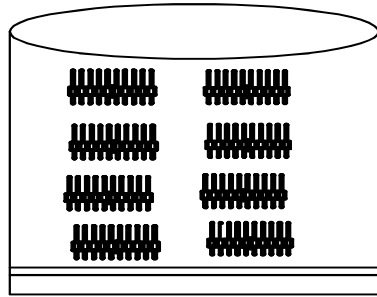
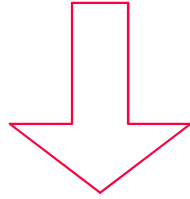

3#胶袋: 16*18cm

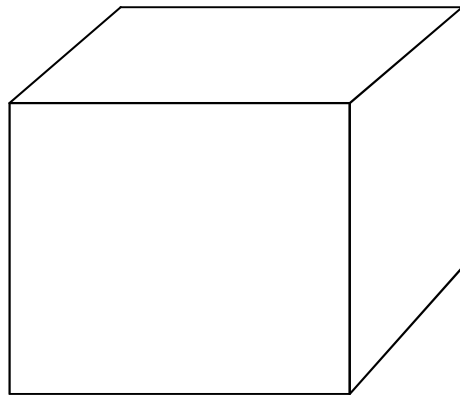
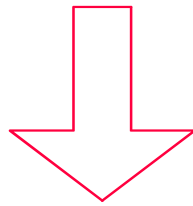

纸箱

插针系列
series
head's arrangement
TM

连接器领域专家
让世界连接更清晰