



### 产品名称 Product name

- ▶ 2.0PH H2.0 1\*nPin 180度
- ▶ 插件 PC2.8 PA3.9 PB2.0 L8.7

### 产品应用场景 Product application scenario

- ▶ 电子通讯/数码产品/家用电器
- ▶ 外围设备/汽车/医疗设备等.
- ▶ Electronic communication/digital products/household appliance peripherals/AuTomobile/medical equipment, etc

排针系列  
Series Needle arrangement™

## 产品参数/Product parameters

额定电流 (Rated current): 1.5A AC/DC

盐雾实验 (Life Test) : 24 hours

接触电阻 (Contact Resistance) : 20mΩ

绝缘电阻 (Insulation Resistance) : 1000MΩ min.

耐电压 (Withstand voltage) : AC 500V

工作温度 (Operating Temperature) : -40° C to 105°

防火等级 (Fire rating) : Polyester (UL94V-0)

触点电镀 (Dielectric Strength) : Gold Flash

耐高温范围/时长 (High temperature resistance range/duration) : 260° C for 5seconds

包装方式 (Packaging method) : 袋装

## 材质/MATERIALS:

No.	名称/NAME	材料/MATERIAL	表面处理/颜色 Surfacetreatment/color
①	端子/Terminal	Brass/C2680	镀金 gold-plating
②	塑胶/plastic cement	PBT/PA6T	黑色 Black

## 产品PIN位示意图/Schematic diagram of product PIN

No. of	DIM. A	DIM. B	No. of	DIM. A	DIM. B	No. of	DIM. A	DIM. B	No. of	DIM. A	DIM. B
1*1P	0.00	2.00	1*11P	20.00	22.00	1*21P	40.00	42.00	1*31P	60.00	62.00
1*2P	2.00	4.00	1*12P	22.00	24.00	1*22P	42.00	44.00	1*32P	62.00	64.00
1*3P	4.00	6.00	1*13P	24.00	26.00	1*23P	44.00	46.00	1*33P	64.00	66.00
1*4P	6.00	8.00	1*14P	26.00	28.00	1*24P	46.00	48.00	1*34P	66.00	68.00
1*5P	8.00	10.00	1*15P	28.00	30.00	1*25P	48.00	50.00	1*35P	68.00	70.00
1*6P	10.00	12.00	1*16P	30.00	32.00	1*26P	50.00	52.00	1*36P	70.00	72.00
1*7P	12.00	14.00	1*17P	32.00	34.00	1*27P	52.00	54.00	1*37P	72.00	74.00
1*8P	14.00	16.00	1*18P	34.00	36.00	1*28P	54.00	56.00	1*38P	74.00	76.00
1*9P	16.00	18.00	1*19P	36.00	38.00	1*29P	56.00	58.00	1*39P	76.00	78.00
1*10P	18.00	20.00	1*20P	38.00	40.00	1*30P	58.00	60.00	1*40P	78.00	80.00

## 产品编号/Product No



- 1: Series No:  
PH-Pin Header
- 2: 焊接板类型/Welding Board Type:  
3-180度单排插件/ Straight DIP Type
- 3: 产品间距/Product spacing  
127-1.27mm  
200-2.00mm  
254-2.54mm
- 4: PIN位/PIN bit  
1\*1P-11P

- 5: 颜色/Color:  
B-Black
- 6: 材料/Material  
1-PBT 2-PA6T
- 7: 触点电镀/Contact Plating  
GO-Gold Flash
- 8: 包装方式/Packgin Method  
P-袋装/PE B-盒装/BOX  
T-管装/Tubing W-卷带/winding
- 9: Serial Code

连接器领域专家

让世界连接更清晰

产品订购号示意图/Schematic diagram of product order number

Schematic diagram of product order number: HB-PH3-20011PB2G0P

产品外形尺寸图/Outline dimension drawing of product

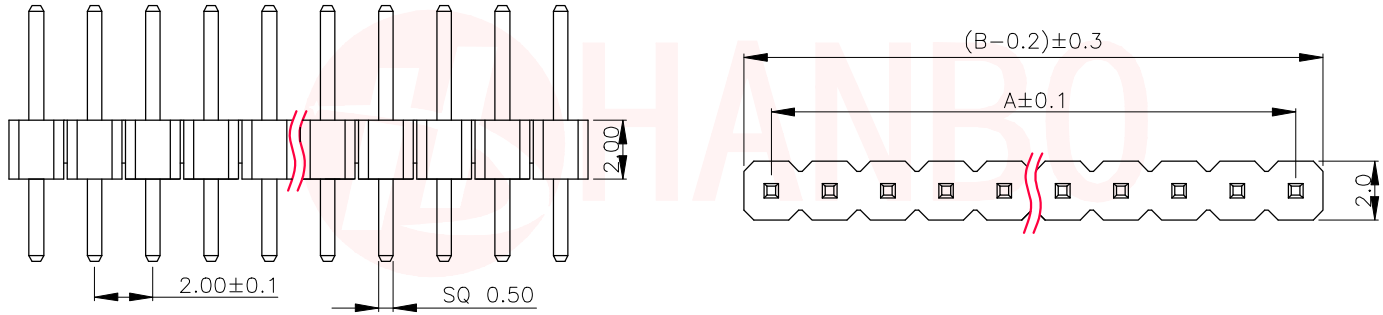

线路图/Circuit diagram

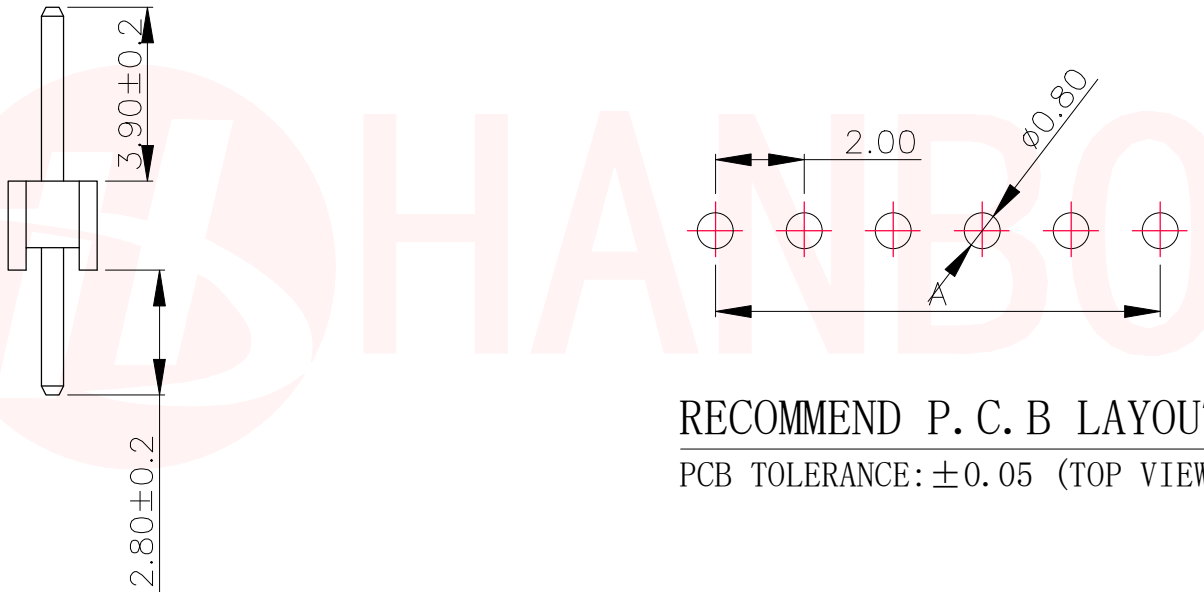

RECOMMEND P. C. B LAYOUT  
PCB TOLERANCE:  $\pm 0.05$  (TOP VIEW)

Series  
Needle arrangement  
™  
系列

连接器领域专家  
让世界连接更清晰

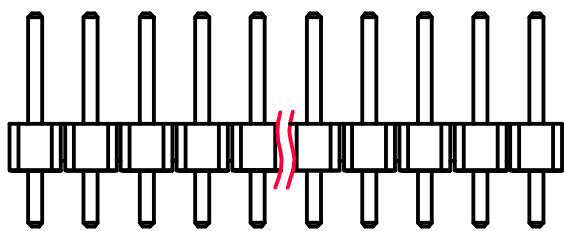

产品

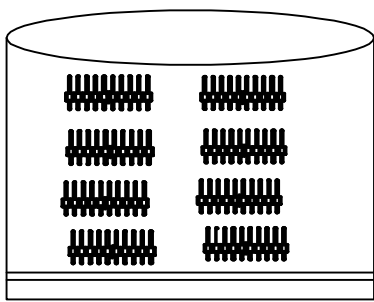
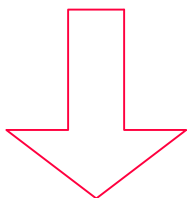

3#胶袋: 16\*18cm

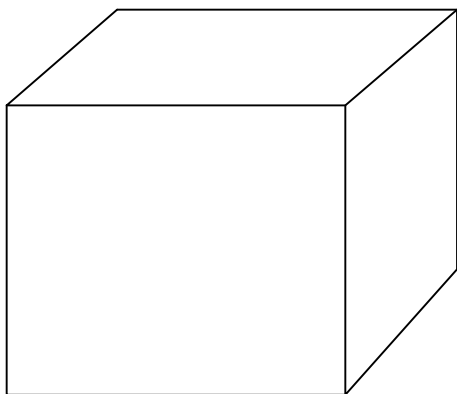
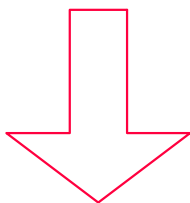

纸箱