

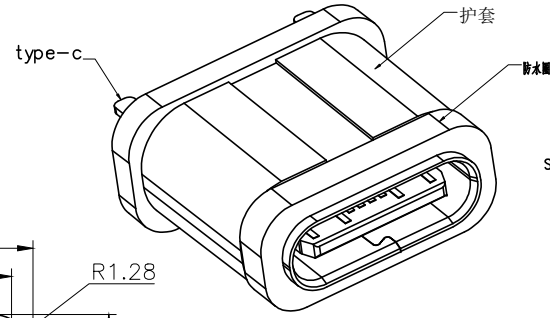

REV.	ECN NO OR DESCRIPTION	REVISED	DATE

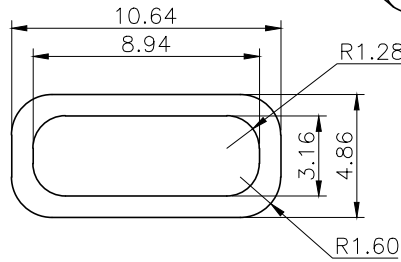

SPECIFICATIONS:
1. ELECTRICAL CHARACTERISTICS:
 1-1. CONTACT RESISTANCE: 30mΩ MAX.
 1-2. DIELECTRIC WITHSTANDING VOLTAGE: 100V AC FOR ONE MINUTE.
 1-3. INSULATION RESISTANCE: 100MΩ MIN. MEASURED BY 500 VDC
2. MECHANICAL CHARACTERISTICS:
 2-1. INSERTION FORCE : 0.5-2.0Kgf(REF.)
 2-2. WITHDRAWAL FORCE : 0.8-2.0Kgf(REF.)
3. LIFE TEST: 10,000 CYCLES.

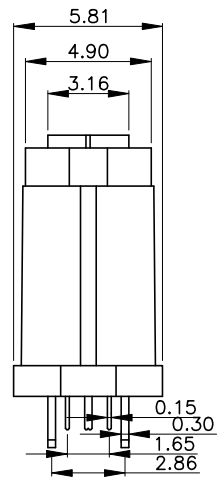
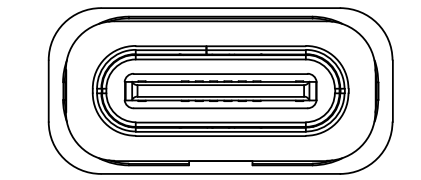
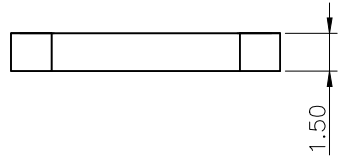
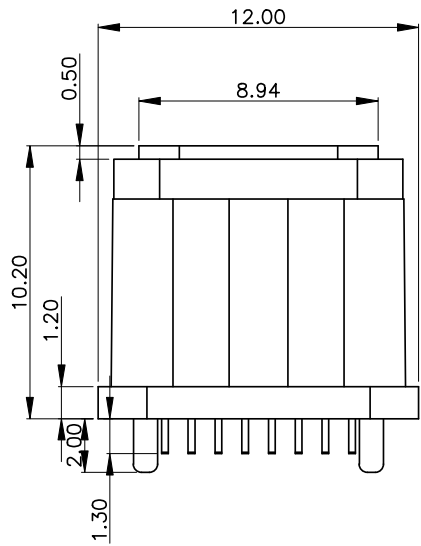

A1	GND	B12	GND
A4	VBUS	B9	VBUS
A5	CC1	B8	SBU2
A6	DP1	B7	DN2
A7	DN1	B6	DP2
A8	SBU1	B5	CC2
A9	VBUS	B4	VBUS
A12	GND	B1	GND
PIN	SIGNAL NAME	PIN	SIGNAL NAME

备注:
 1. 材质硅橡胶, 防水密封用
 2. 黑色材料
 3. 材料符合RoHS

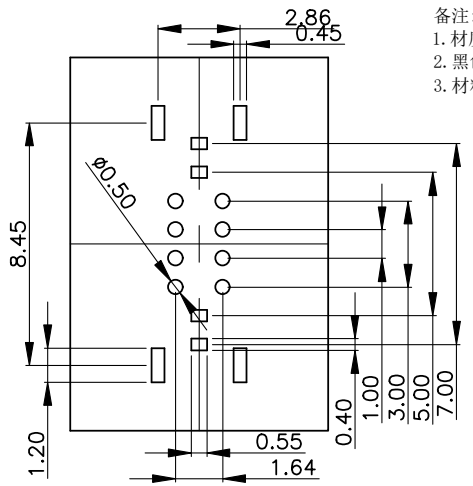
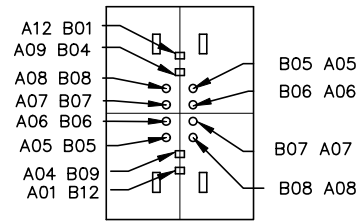

RECOMMENDED P.C.B. LAYOUT (T:1.00mm)
TOLERANCE UNSPECIFIED ±0.05mm

6	SHELL	STAINLESS STEEL	NI Plated	1PCS
5	SHIELDING PLATE	STAINLESS STEEL	---	1PCS
4	MD	HIGH TEMPERATURE PLASTIC	BLACK	1PCS
3	CONTACT	COPPER ALLOY	Au/Ni Plated	1SET
2	CONTACT	COPPER ALLOY	Au/Ni Plated	1SET
1	HOUSING	HIGH TEMPERATURE PLASTIC	BLACK	1PCS
NO.	DESCRIPTION	MATERIAL	REMARKS	QTY

UNLESS OTHERWISE SPECIFIED TOLERANCES

DECIMALS: X :±0.35 X.X :±0.25 X.XX :±0.15

ANGLES: X :±2° X.X :±1°

东莞市汉博电子科技有限公司
DONGGUAN HANBO TECHNOLOGY CO., LTD

TITLE: TYPE C 16PIN 180度防水IP67

DWN xiong PART NO. MC-101FLD

CHKD lee SCALE:1:1 UNIT: mm

APVD wang SIZE: A4 SHEET:10F 1 REV: A4

CUSTOMER COPY

A
B
C
D

A
B
C
D